

Equipment Covers

ECO² C-Arm

CODE	DESCRIPTION	CASE QTY	CASE DIMENSIONS
E46-CARM13-S	ECO ² C-Arm Pack 9" (23cm) for OEC/GE 9800	50	24x20x18" (60x50x45cm)

Materials

- ECO² Clear Polyethylene (PE) Film
- ECO² Polypropylene (PP)
- ECO² Polypropylene (PP) Filament String

Product Attributes

- Certain components of this product incorporate ECO² sustainable materials which enhance product biodegradability
- Fits GE OEC 9800 C-Arm
- Plastic clip securement
- Includes 2 rectangular band bags
- Includes 1 footswitch cover

Sterilization

Sterile: Sterilized by EO (ethylene oxide). Product is sterile unless the package has been damaged or opened.

Shelf Life

Sterile: 5 years

Product Certifications/Standards

- Sterile: CE certified as Class I, according to MDD93/42/EEC Annex IX, Rule 1
- ASTM D5511-12 Standard Test Method for Determining Anaerobic Biodegradation of Plastics Materials Under High-Solids Anaerobic Digestion Conditions

Manufacturing Certifications/Registrations

- EN ISO 13485:2016
- Medical Device Single Audit Process Certified

Storage

- General warehouse conditions

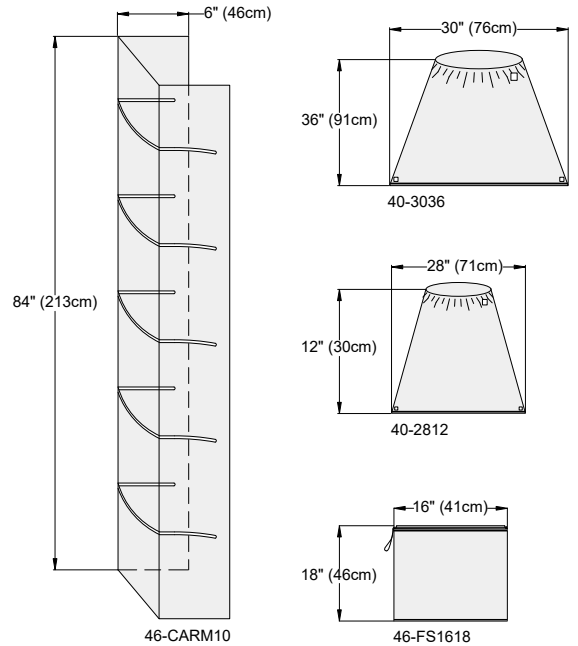

Alleset
4142 Industry Way
Flowery Branch, GA 30542,
USA
www.alleset.com
SM-TDS-003 2023
Country of Origin Abbreviations per ISO 3166-1, Alpha-2 Codes.



GRI Medical & Electronic Technology Co., LTD
1805 Honggao Road,
314031 Jiaxing, Zhejiang
PEOPLE'S REPUBLIC OF CHINA
www.alleset.com
US FDA Establishment Registration #3004911384



Emergo Europe B.V.
Westervoortsedijk 60,
6827 AT Arnhem,
The Netherlands
www.emergobyul.com

